

For your safety, please read the following before using.

- ① Do not use corrosive or flammable gas or liquid with this product.
- ② Please use within the rating pressure range. Do not apply pressure beyond recommended maximum withstand pressure, permanent damage to the pressure sensor may occur.
- ③ Do not drop, hit or allow excessive shock. Even if switch body appears undamaged, internal components may be broken and can cause malfunction.
- ④ Turn power off before connecting wiring. Wrong wiring or short circuit will damage and/or cause malfunction.
- ⑤ Do not use in environment containing steam or oil vapor.
- ⑥ This product is not explosion-proof rated. Do not use in atmosphere containing flammable or explosive gases.
- ⑦ Wiring for pressure sensor should avoid power source line and high voltage line. If use in the same circuit, noise may cause malfunction.

A. SPECIFICATIONS		EP43P-□-□ (Positive)	EP43V-□-□ (Vacuum)	EP43C-□-□ (Compound)
Rated pressure range		0.000 ~ 1.000MPa	0.0 ~ -101.3kPa	-100.0 ~ 100.0kPa
Setting pressure range		-0.100 ~ 1.000MPa	10.0 ~ -101.3kPa	-101.0 ~ 101.0kPa
Withstand pressure		1.5MPa	300kPa	
Fluid		Filtered air, Non-corrosive / Non-flammable gas		
Set pressure resolution	kPa	—	0.1	
	MPa	0.001	—	
	kgf/cm ²	0.01	0.001	
	bar	0.01	0.001	
	psi	0.1	0.01	
	inHg	—	0.1	
	mmHg	—	1	
Power supply voltage		12 to 24V DC ±10%, Ripple (P-P) 10% or less		
Current consumption		≤ 40mA (With no load)		
Switch output		NPN: open collector 2 outputs Max. load current: 125mA Max. supply voltage: 30V DC Residual voltage: ≤ 1.5V	PNP: open collector 2 outputs Max. load current: 125mA Max. supply voltage: 24V DC Residual voltage: ≤ 1.5V	
Repeatability (Switch output)		±0.2% F.S. ±1 digit		
Hysteresis	One point set mode	Adjustable (*1)		
	Hysteresis mode			
	Window comparator mode			
Response time		≤ 2.5ms (chattering-proof function: 25ms, 100ms, 250ms, 500ms, 1000ms and 1500ms selections)		
Output short circuit protection		Yes		
7 segment LCD display		Two color(Red/Green) main & unit display, Orange sub-display (Sampling rate: 5 times/1sec.)		
Indicator accuracy		±2% F.S. ±1 digit (ambient temperature: 25 ±3°C)		
Switch ON Indicator		Orange (1 & 2 Indicator) OUT1 OUT2		
Analog output (Voltage Output) *2		Output Voltage: 1 to 5V ±2.5% F.S. (within rated pressure range) Linearity: ±1% F.S. Output impedance: about 1kΩ		
Analog output (Current Output) *3		Output Current: 4 to 20mA ±2.5% F.S.(within rated pressure range) Linearity: ±1% F.S. Max.Load Impedance: 300Ω at power supply of 12V 600Ω at power supply of 24V Min.Load impedance: 50Ω		
Environment	Enclosure	IP40		
	Ambient temp. Range	Operation: 0 ~ 50°C, storage:-10 ~ 60°C (No condensation or freezing)		
	Ambient humidity range	Operation/Storage: 35 ~ 85% RH (No condensation)		
	Withstand voltage	1000V AC in 1-min (between case and lead wire)		
	Insulation resistance	50MΩ (at 500V DC, between case and lead wire)		
	Vibration	Total amplitude 1.5mm or 10G,10Hz-55Hz-10Hz scan for 1 minute, two hours each direction of X, Y and Z		
	Shock	100m/s ² (10G), 3 times each in direction of X, Y and Z		
Temperature characteristic		±2.5% F.S. of detected pressure (25°C) at temp. Range of 0~50°C		
Port size		F1:R1/8", M5 ; F2:NPT1/8", #10-32 UNF ; F3: G1/8"(BSPP), M5		
Lead wire		Oil-resistance cable(0.15mm ²)		
Weight		Approx. 80g (with 2 meter lead wire)		

*1. Hysteresis value is adjustable within 1~8 digits for one point set mode and window comparator mode.

*2. If analog voltage output is selected, the analog current output cannot be selected at the same time.

*3. If analog current output is selected, the analog voltage output cannot be selected at the same time.

B. ORDERING INFORMATION

EP43C-010-F1

Pressure Range

C : Compound (-101.0 ~ 101.0 kPa)
 V : Vacuum (10.0 ~ -101.3 kPa)
 P : Positive (-0.100 ~ 1.000 MPa)

Pressure Port

F1 : R1/8", M5
 F2 : NPT1/8", #10-32UNF
 F3 : G1/8"(BSPP), M5

Output Specifications

010 : 2 NPN + Analog (Voltage) output (1~5V)
 011 : 2 NPN + Analog (Current) output (4~20mA)
 02 : 2 NPN + Copy function
 030 : 2 PNP + Analog (Voltage) output (1~5V)
 031 : 2 PNP + Analog (Current) output (4~20mA)
 04 : 2 PNP + Copy function

Optional Parts

BT-12 : Mounting bracket
 BT-13 : Mounting bracket
 PA-C : Panel adapter
 PA-D : Panel adapter + Front protective lid

C. PANEL DESCRIPTION

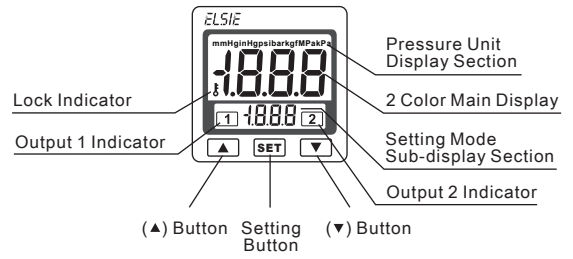

D. OUTPUT CIRCUIT WIRING DIAGRAMS

EP43 □ -010- □
 2 NPN+Analog Output (1~5V)

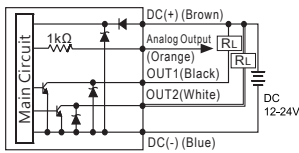

EP43 □ -011- □
 2 NPN+Analog Output (4~20mA)

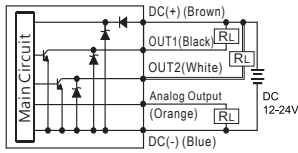

EP43 □ -02- □
 2 NPN+Copy Function

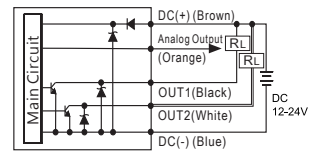

EP43 □ -030- □
 2 PNP+Analog Output (1~5V)

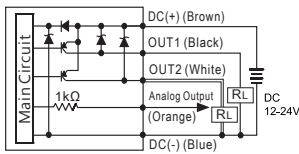

EP43 □ -031- □
 2 PNP+Analog Output (4~20mA)

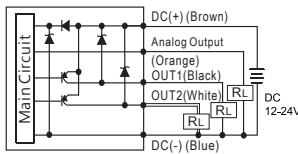

EP43 □ -04- □
 2 PNP+Copy Function

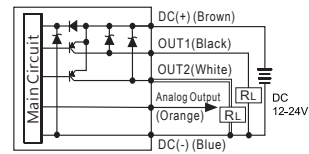

E. DIMENSIONS

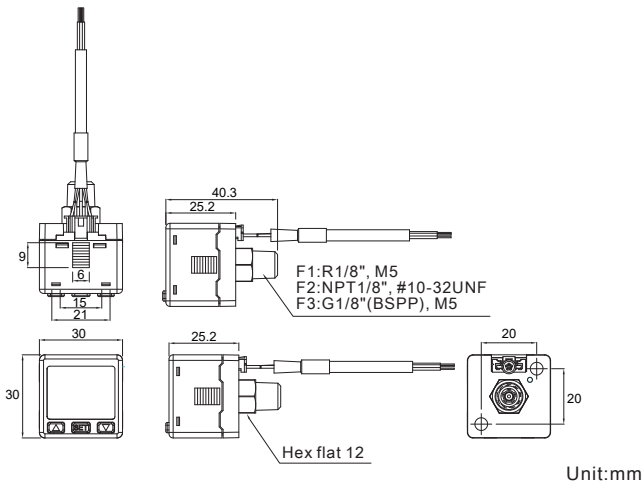

F. OPTIONAL PARTS DIMENSIONS

① Mounting bracket

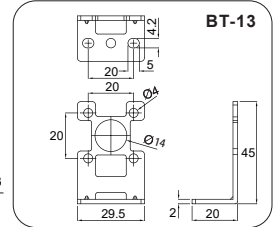
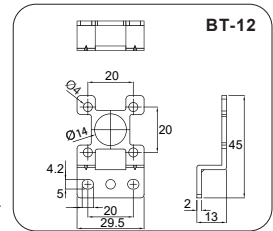
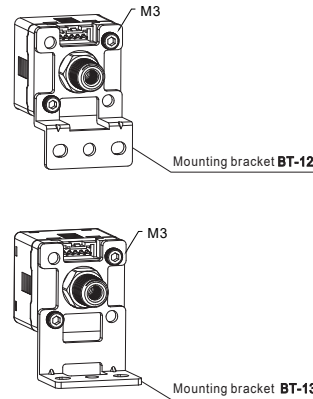

F. OPTIONAL PARTS DIMENSIONS

② Panel Mounting

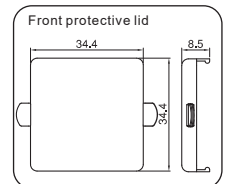
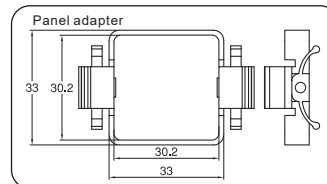
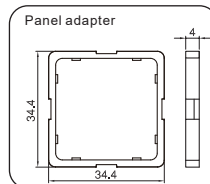
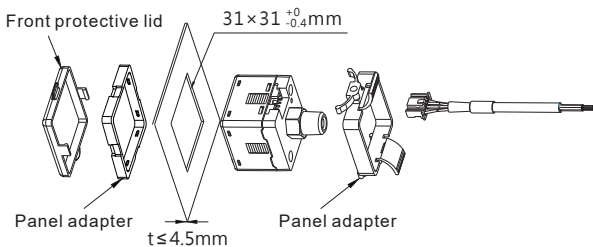

Unit:mm

G. INITIAL SETTING MODE

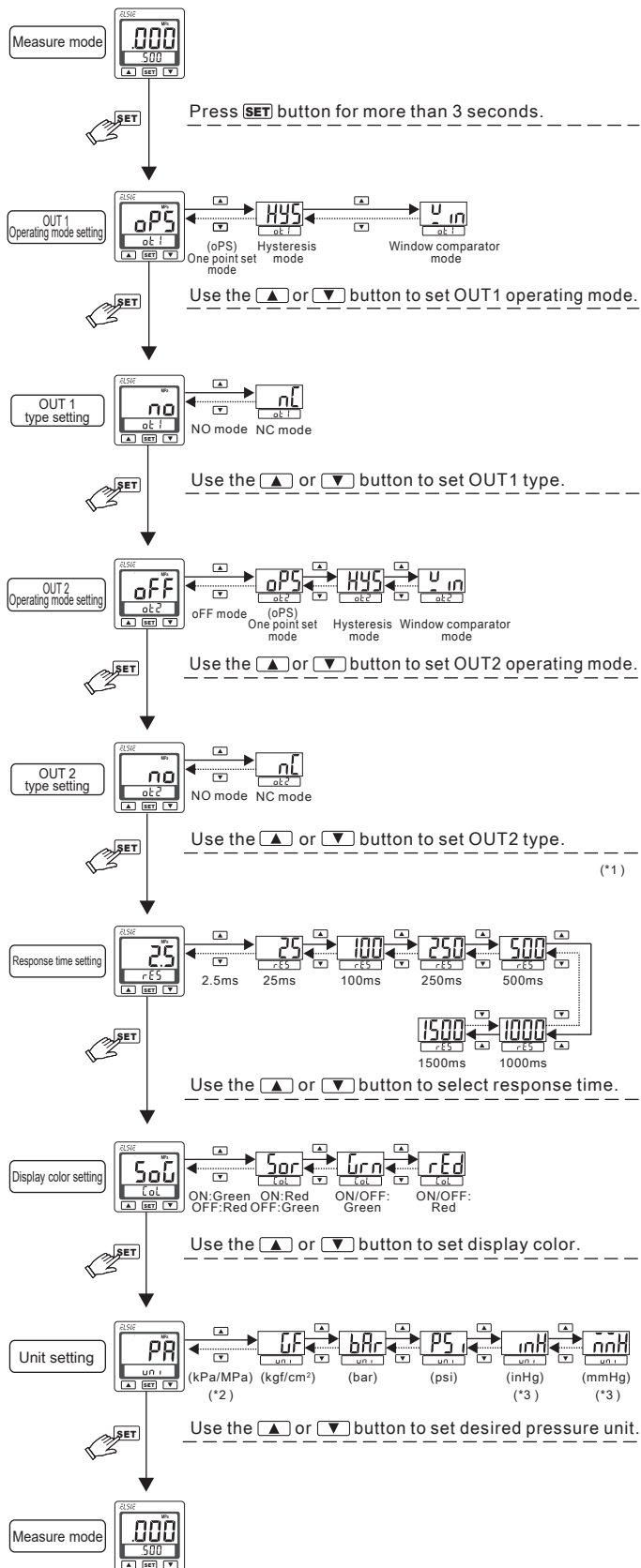

【NOTE :】

- *1. This setting mode will not display when output 2 is set to oFF.
- *2. Pressure unit is MPa with positive pressure.
Pressure unit is kPa with vacuum and compound pressure.
- *3. Only applicable for Vacuum/Compound.

H. ADVANCE SETTING MODE

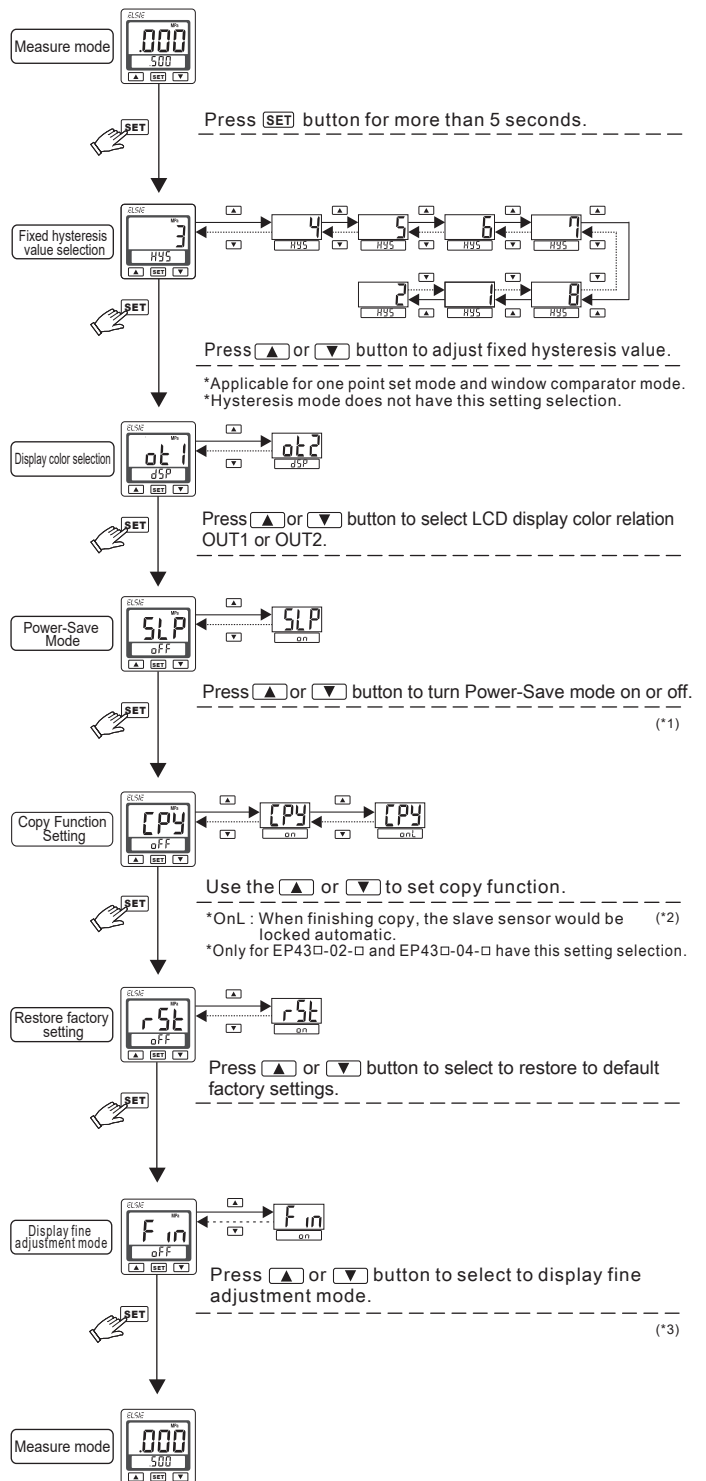

【NOTE :】

- *1. When setting is "on", the power-save mode is active. Please refer to the item "□" in detailed.
- *2. When setting is "on" or "nL", the display copy function mode is active. Please refer to the item "□" in detailed.
- *3. When setting is "on", the display fine adjustment mode is active. Please refer to the item "□" in detailed.

I. PRESSURE SETTING MODE

Setting Condition 1 :

OUT 1 mode setting :
" oP5 " (One point set mode)
OUT 2 mode setting :
" oFF " (Not used)

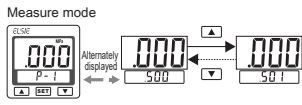

Setting Condition 2 :

OUT 1 mode setting :
" oP5 " (One point set mode)
OUT 2 mode setting :
" oP5 " (One point set mode)

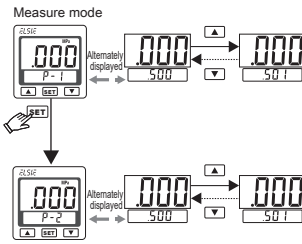

Setting Condition 3 :

OUT 1 mode setting :
" oP5 " (One point set mode)
OUT 2 mode setting :
" H95 " (Hysteresis mode)
" u.in " (Window comparator mode)

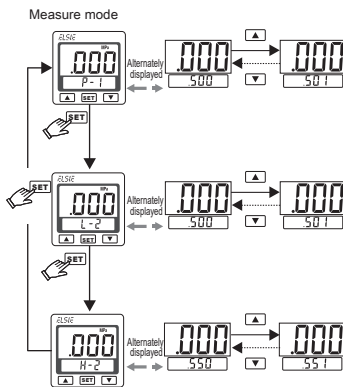

Setting Condition 4 :

OUT 1 mode setting :
" H95 " (Hysteresis mode)
" u.in " (Window comparator mode)
OUT 2 mode setting :
" oFF " (Not used)

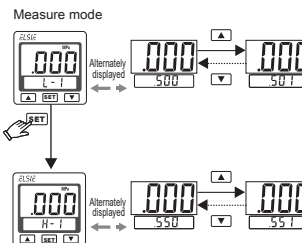

Setting Condition 5 :

OUT 1 mode setting :
" H95 " (Hysteresis mode)
" u.in " (Window comparator mode)
OUT 2 mode setting :
" oP5 " (One point set mode)

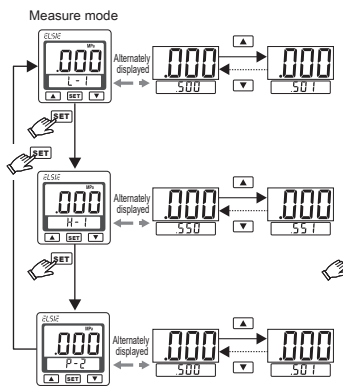

Setting Condition 6 :

OUT 1 mode setting :
" H95 " (Hysteresis mode)
" u.in " (Window comparator mode)
OUT 2 mode setting :
" H95 " (Hysteresis mode)
" u.in " (Window comparator mode)

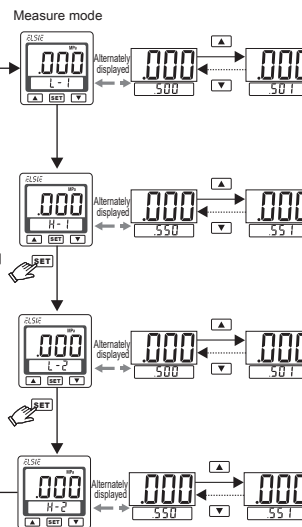

[NOTE :]

Do not disconnect power when the sub-display and setting value is flashing alternately; otherwise the system cannot store the values.

J. OUTPUT TYPE

(1) One point set mode:

Normal open mode

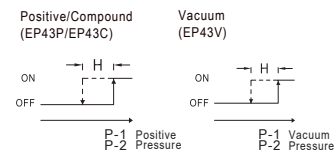

Normal close mode

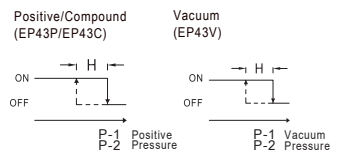

(2) Hysteresis mode:

Normal open mode

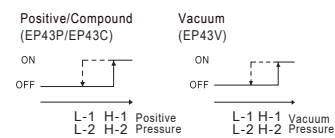

Normal close mode

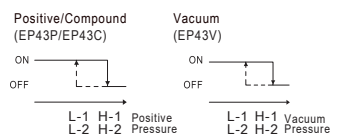

(3) Window comparator mode:

Normal open mode

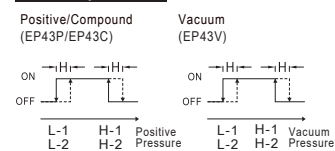

Normal close mode

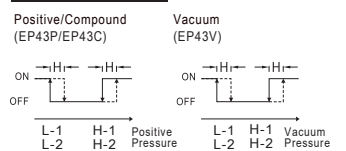

[NOTE :]

- *1. In case hysteresis is set at less than or equal to 2 digits, switch output may chatter if input pressure fluctuates near the set point.
- *2. When using window comparator mode, the difference between two set points must be greater than the fixed hysteresis, otherwise will cause the switch output to malfunction.

K. ANALOG OUTPUT DESCRIPTION

Analog output range 1-5V or 4-20mA, proportional to the pressure range.

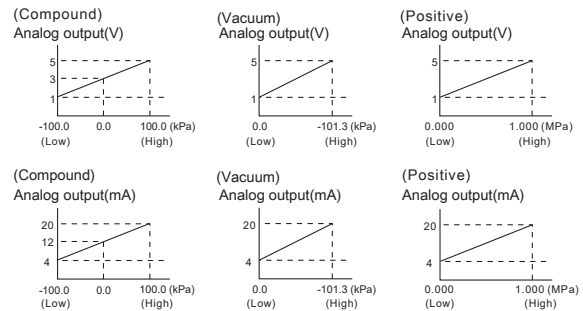

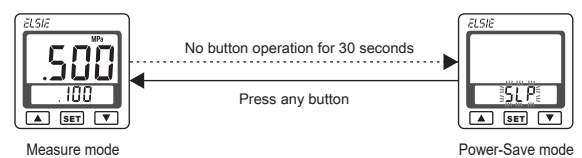

L. POWER-SAVE MODE

- During Power-Save mode, the main display will turned off if no buttons is pressed after 30 seconds.
- During Power-Save mode, the output LCD may not be synchronize with the output. It is normal and will not affect output operation.
- Press any button to turn-on main display temporarily.



(Main display is off, sub-display will flash " 5 L P ")

M. ZERO POINT SETTING

Press the  +  button at the same time until the "00" is shown.
Release the button to end zero setting.

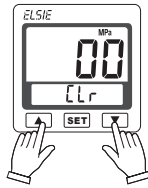

P. KEY LOCK/UNLOCK MODE

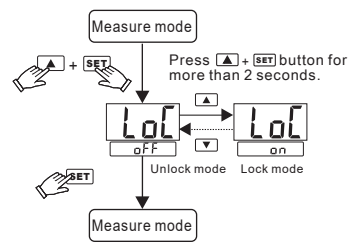

- ⊙ Use key lock mode to prevent unauthorized or accidental tampering with the switch setting.
- ⊙ When lock mode is selected, panel will display "LoL".



N. PEAK/BOTTOM HOLD FUNCTION

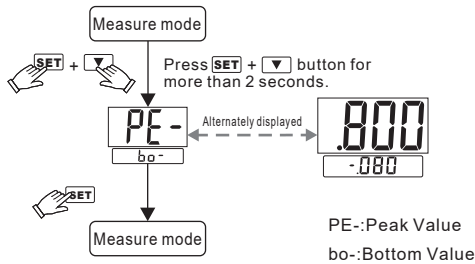

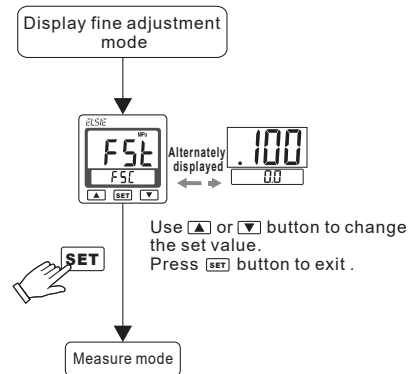

Q. FINE ADJUSTMENT MODE







O. COPY FUNCTION SETTING

- ⊙ Copy function setting can use the master sensor to copy the pressure value to the slave sensors.
- ⊙ Before copying, please confirm the model of pressure sensor. The function cannot use in difference mode.
- ⊙ The copy function only can be one-to-one.

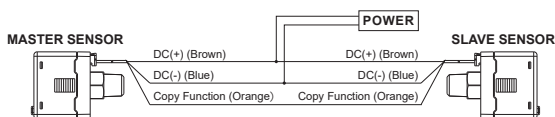
[SETTING STEP]

- Please set the copy function to  or  to be on copy condition by master sensor. Please refer the copy setting of (H) advance setting mode.
- Turn power off to both sensor.
- Refer the connection way with the master and slave sensor as followings.





- Turn on power at same time. (* 1)
- Wait 5 sec., when finishing to convey the data, the master sensor display (alternately display)  the slave sensor display (alternately display) .
- When convey the data failed, (Master) sensor displays  (Slave) sensor displays  (* 2)
- Turn off power and remove the wire connection. If no remove the wire connection, the sensor would be broken.

- ★ If require to copy another slave sensor, please repeat the step ③ to ⑤.
- ★ Only for EP43□-02-□ and EP43□-04-□ have this setting selection.

[NOTE]

- *1. If turn on power is not synchronization, the data cannot be copied.
- *2. When the data conveys failed, please check the wire connection. Then repeat the step ③ to ⑤.

- ⊙ **How to cancel the copy mode :**
When the master sensor display  (display reciprocal), Please  button to leave the copy mode.

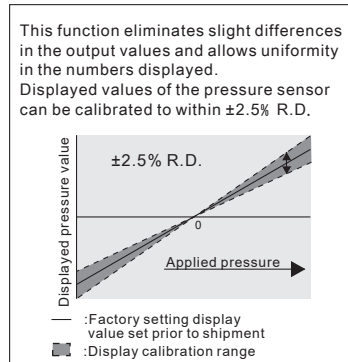

R.D. (Real Detect)

- [NOTE :]
- Setting resolution is ±0.1% R.D.
 - The signal would be changed with analog output after adjusting.

R. ERROR CODE INSTRUCTION

Error Type	Error code	Error Condition	Troubleshooting
Excess load current error	Er 1	Output 1 load current is more than 125 mA	Turn power off and check the cause of overload current or lower the current load under 125 mA, then restart.
	Er 2	Output 2 load current is more than 125 mA	
Residual pressure error	Er 3	During zero reset, ambient pressure is over ±3% F.S.	Change input pressure to ambient pressure and perform zero reset again.
Applied pressure error	HHH	Supply pressure exceeds the upper limit of pressure setting.	Adjust the pressure within operating pressure range.
	LLL	Supply pressure exceeds the lower limit of pressure setting.	
System error	Er 4	Internal system error	Turn power off, and then restart. If error condition remains, please return to factory for inspection.
	Er 5	Internal system error	
	Er 6	Internal data error	
	Er 7	Internal data error	
Copy data error	Er 8	Please check the model no. and wire connection. Restart to turn on power if no return to normal condition, please return to factory for inspection.	

S. PRESSURE UNIT CONVERSION TABLE

From	To	Pa	kPa	MPa	kgf/cm ²	mmHg	psi	bar	inHg
1 Pa		1	0.001	0.000001	0.000010197	0.00750062	0.000145038	0.00001	0.0002953
1 kPa	1000.000		1	0.001000	0.010197	7.500616	0.145038	0.010000	0.2953
1 MPa	1000000	1000		1	10.197	7500.616	145.038	10	295.2998
1 kgf/cm ²	98066.5	98.0665	0.0980665		1	735.559	14.2233	0.980665	28.95979
1 mmHg	133.32	0.13332	0.000133	0.0013595		1	0.019336	0.0013332	0.039370
1 psi	6895	6.895	0.006895	0.07031	51.7157		1	0.06895	2.036074
1 bar	100000.0	100.0000	0.100000	1.01972	750.062	14.5038		1	29.52998
1 inHg	3386.388	3.386388	0.003386	0.034530	25.40000	0.491141	0.033863		1